

USERS GUIDE

SW-M61



E-Bike Display
Model: SW-M61
Protocol: UART2.0
Version: V6.03



Scan QR Code
to Download PDF

Changzhou Sciwil E-Mobility Technology Co., Ltd.



Wechat



Website

Contents

I . Safety Notes	3
II . Overview	4
1. Product Name and Model	4
2. Product Introduction.....	4
3. Specifications.....	4
4. Function.....	4
5. Size.....	5
6. Assembly.....	5
7. Serial Code.....	6
III. Operation	6
1. Display Interface	6
1.1 Riding Interface.....	6
1.2 Setting Interface.....	7
1.3 Error Interface.....	8
2. Key Pad	8
3. Key Operation	8
3.1 On/Off.....	9
3.2 Assist Level.....	9
3.3 Toggle Displays.....	10
3.4 Light On/Off.....	10
3.5 Walk Assist Mode.....	11
4. Settings	11
5. Error Code	20
6. Connection	21
IV. Warranty	21
V. Version	22

I . Safety Notes

PLEASE TAKE CAUTION WHEN USE, DO NOT PLUG OR UNPLUG THE DISPLAY WHILE YOUR E-BIKE IS POWERED ON.

- AVOID CLASHES OR BUMPS TO THE DISPLAY.

- AVOID USING IN HEAVY RAINS, SNOWS OR LONG EXPOSURE TO STRONG SUNLIGHT. DO NOT TEAR THE WATER-PROOF FILM ON THE SURFACE OF THE SCREEN, OTHERWISE THE WATER-TIGHT PERFORMANCE OF THE PRODUCT MAY BE DEGRADED.

- DO NOT PLUG OR UNPLUG THE DISPLAY WHILE THE SYSTEM IS POWERED ON. UNAUTHORIZED ADJUSTMENT TO DEFAULT SETTINGS IS NOT SUGGESTED, OTHERWISE NORMAL USE OF YOUR E-BIKE CAN NOT BE GUARANTEED.

- WHEN THE DISPLAY PRODUCT DOES NOT WORK PROPERLY, PLEASE SEND IT FOR AUTHORIZED REPAIR IN TIME.

II. Overview

1. Product Name and Model

Product Name: E-Bike Display

Product Model: SW-M61

2. Product Introduction

SW-M61 features high-brightness color LCD and minimalist interface, working as an ideal HMI solution for EN15194 electric bikes.

3. Specifications

- Working Voltage: DC 24V/36V/48V/60V/72V
- Rated Working Current: 12mA
- Leakage current: <1uA
- Screen Size: 3.5" TFT
- Communication Type: UART (by default) / CAN (optional)
- Optional Functions: Bluetooth, NFC
- Working Temperature: -20°C ~ 60°C
- Storage Temperature: -30°C ~ 70°C
- Waterproof Rating: IP65

4. Function

- Boot password
- System unit switch (km/h or mph)
- Assist Level Control and Display
- Battery indication: battery level percentage, low voltage indication
- Speed display: (in km/h or mph)
 - real-time speed (SPEED), max speed (MAX), average speed (AVG)
- Distance: single-trip distance (TRIP), total travel distance (ODO)
- Assist Mode Control and Display (3/5/9 levels)
- Walk assist mode
- Front light indication: front light status supported by controller.
- Error code indication
- Riding Info: Braking Status, Front Light Status, Cruise, Low Voltage.

- Turning Signals: This function works with controller.
- Dual Drive Control and Display: This function works with controller.
- Status of Double Battery Packs: optional, works with controller.
- NFC Function: optional.
- Bluetooth Connection: optional, support OTA upgrade via mobile phone.

5. Size

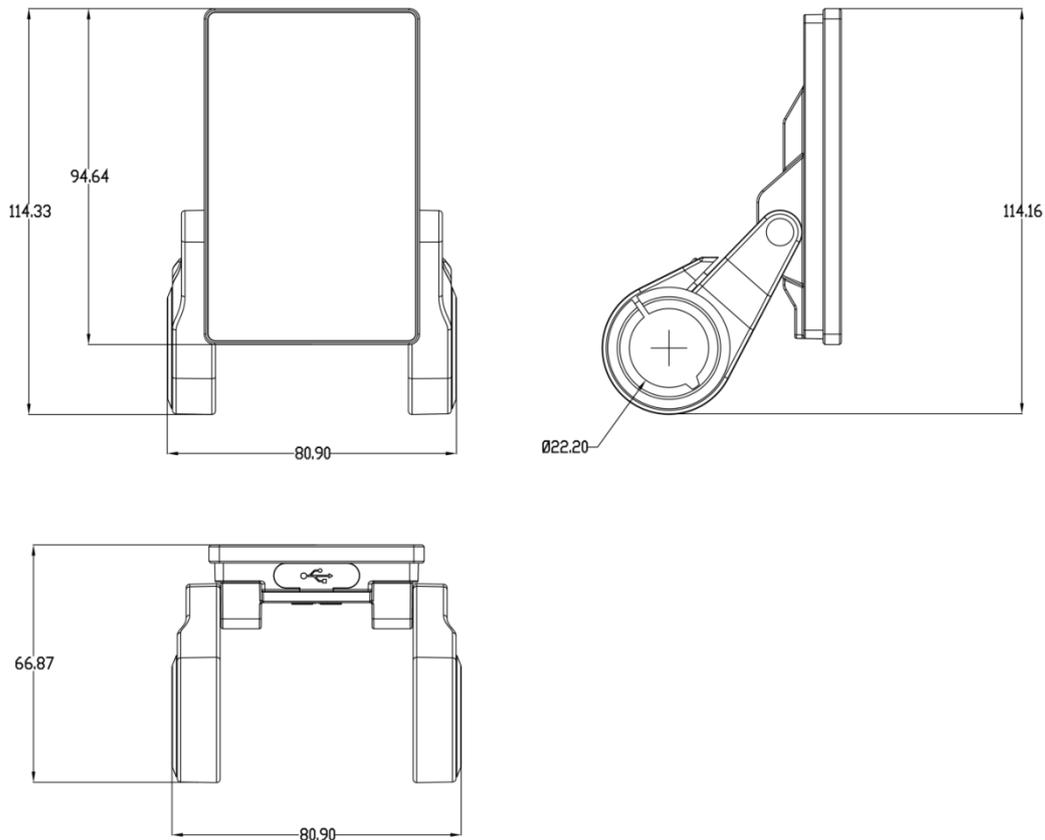

6. Assembly

- ① Open the holder ring/rubber spacer of the display and fix the display on the handlebar, adjust it to a proper facing angle. Use a M4 Hex Wrench to fix and tighten the screws. Standard fixing torque: **1N·m**.
*Damage due to excessive fixing torque is not covered by warranty.
- ② Open the holder ring/rubber spacer of the keypad and fix it on the handlebar, adjust it to a proper facing angle. Use a M3 Hex Wrench to fix and tighten the screws. Standard fixing torque: **1N·m**.

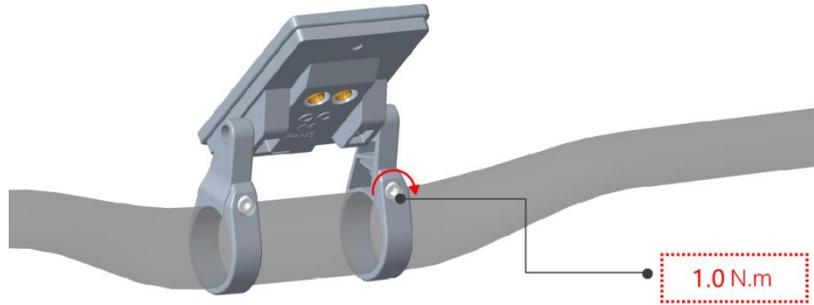

*Damage due to excessive fixing torque is not covered by warranty.

③ Plug the 5-pin connector of the display to the coupling connector of the Controller.

7. Serial Code

Example: **111 22 333333 555 6666** **36V** ← Marked at the back of display

111: Customer Code

22: Protocol Code

333333: P.O. Date (YYMMDD)

555: Order Receiving Number

6666: Production Date (YYMM)

III. Operation

1. Display Interface

1.1 Riding Interface

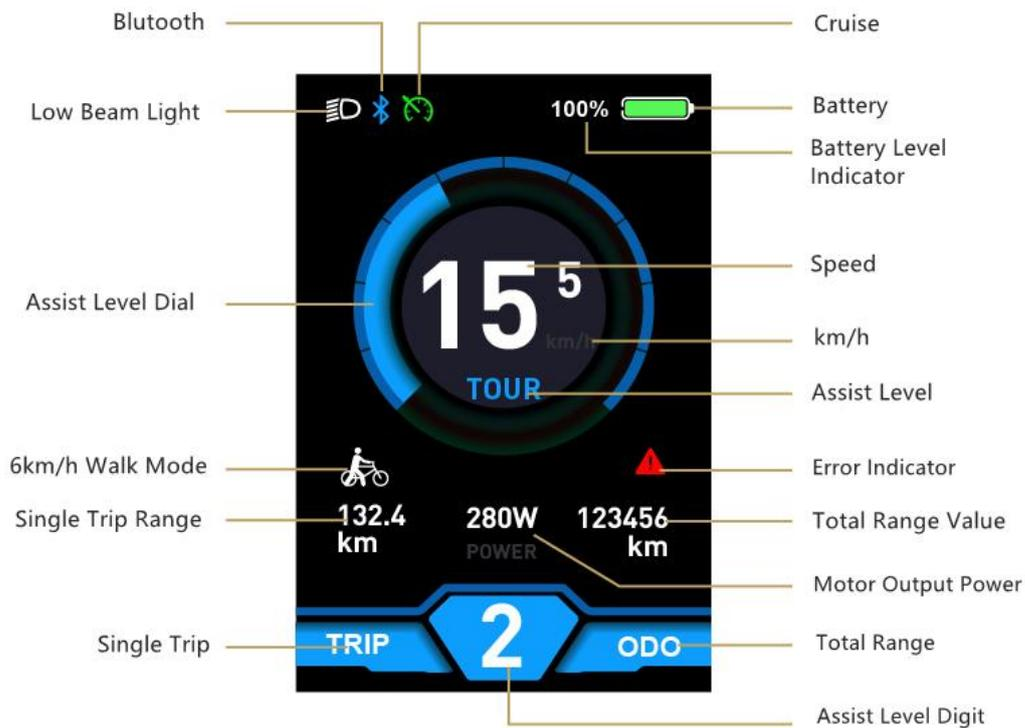

- Status: Real-time Riding Status: Bluetooth, Front Light, Brake, Low Voltage, Turning, Cruise, Drive Status, etc.
- Battery Status: Residual Battery Percentage
- Multi-Function Section: ODO (total range), TRIP (single ride range), MAX (max. speed), AVG (average speed), TIME (riding time), VOL (battery voltage), Wh (motor power), CUR (current), etc.
- Assist Level Mode: 3/5/9 Levels available.

1.2 Setting Interface

MENU	
Display Settings	
→ System Unit	km/h
Brightness	
Auto-off	OFF
Auto Lamp	OFF
EXIT	

In the above interface: Setting Item: System Unit, Parameter Value: km/h

1.3 Error Interface

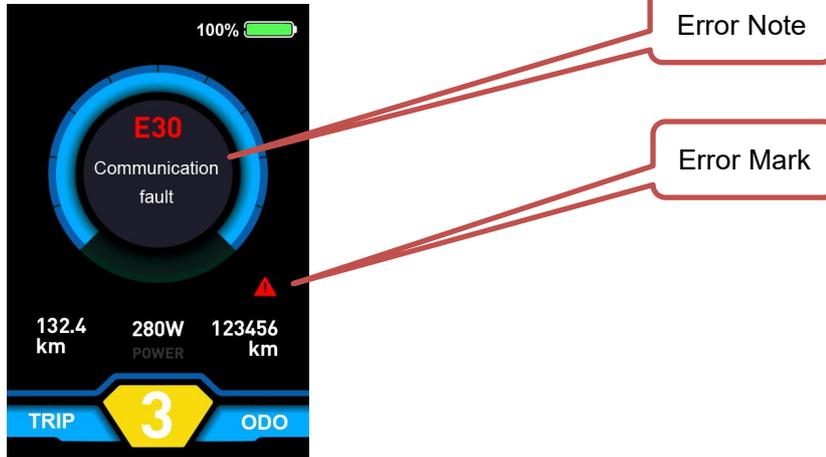

In the above interface: Error Indicator: ERROR, Error Note: Communications Error

2. Key Pad

SWK2 Keypad Illustration:



There are 5 keys on the SWK2 keypad, in the following instructions:

- +** is called Plus Key;
- ⏻** is called On/Off Key;
- is called Minus/Walk Assist Key;
- 💡** is called Light Key;
- i** is called Info Key;

3. Key Operation

Key operation guide as follows:

Press and Hold: means press and hold the key(s) for more than 2s.

Press: means press the key(s) for less than 0.5s.

Double Tap: means double tap the key(s) within 0.3s

3.1 On/Off

Turn on the Display: When the display is off, press and hold the On/Off Key to turn on the display, it will show boot interface and then enter riding interface. (If boot password is activated, enter the boot password at start).

Turn off the Display: When the display is on, press and hold the On/Off Key, the display will be turned off. If no operation is engaged for 10min (0km/h), the display will be auto-off. Auto-off time can be set in the Settings.

3.2 Assist Level

Press the Plus Key or Minus/Walk Assist Key to switch assist levels. There are 5 levels by default: 0/1/2/3/4/5. 0 means no assist power.

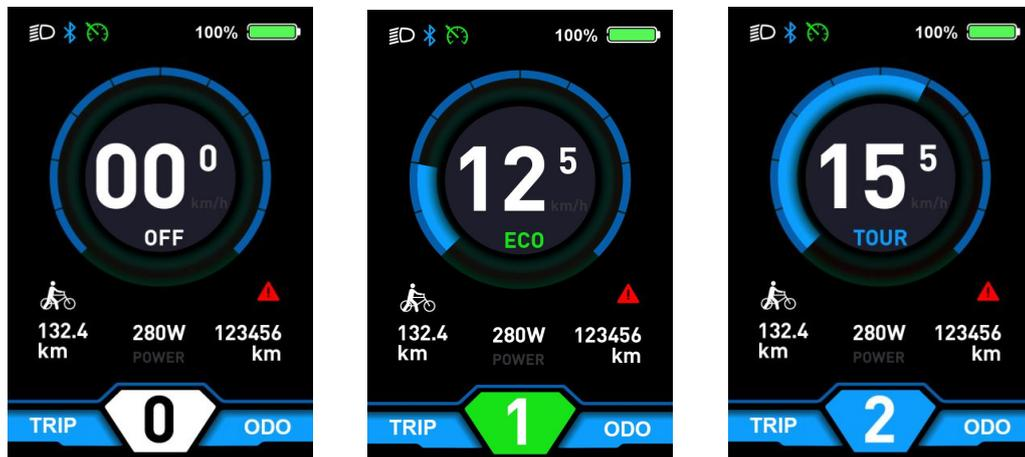

Level0

Level1

Level2



Level3



Level4



Level5

3.3 Toggle Displays

When the display is on, press the Info Key to toggle among ODO (total range), Trip (single trip range), TIME (riding time) etc.



3.4 Light On/Off

Turn on the Front Light: when the front light is off, press the Light Key to turn it on, and the light icon will be shown on the riding interface (to remove this functions, please reconfigure the controller).

Turn off the Front Light: when the front light is on, press the Light Key to turn it off, and the light icon will be off on the riding interface.



3.5 Walk Assist Mode

Engage Walk Assist Mode: On the riding interface, press and hold the Minus/Walk Assist Key to enter walk assist mode. Hold the Minus/Walk Assist Key to engage walk assist mode, the walk mode icon will be shown on the riding interface, the real-time speed will be shown in the speed section.

Disengage Walk Assist Mode: release the Minus/Walk Assist Key to disengage the walk assist mode, the icon will off on the riding interface.



4. Settings

4.1 Setting Operations

① **Enter the Settings:** when the display is on, press and hold the Plus Key and the Minus/Walk Assist Key together to enter the Settings. Available setting items include: system voltage, wheel size (inch), magnetic steel number for speed gauge, speed limit etc (please refer to 4.2 Setting Items).

② **Adjust Settings:** on the Settings interface, press the Plus Key or the Minus/Walk Assist Key to set values for items. The value will blink after change. Press the On/Off Key to save the set value and switch to next item.

③ **Save and Exit Settings:** press and hold again the Plus Key and the Minus/Walk Assist Key together to exit the Settings and save the set value. The system will save and exit automatically if there's no operation for 10s.

4.2 System Unit: km/h or mph

Press Plus or Minus to choose metric (km/h) or imperial (mph) unit.

MENU	
Display Settings	
→ System Unit	km/h
Brightness	IIII
Auto-off	OFF
Auto Lamp	OFF
EXIT	

MENU	
Display Settings	
→ System Unit	mph
Brightness	IIII
Auto-off	OFF
Auto Lamp	OFF
EXIT	

4.3 Backlight Brightness

Press Plus or Minus to choose among I~IIII. I is darkest, IIII is brightest

MENU	
Display Settings	
System Unit	km/h
→ Brightness	I
Auto-off	OFF
Auto Lamp	OFF
EXIT	

MENU	
Display Settings	
System Unit	mph
→ Brightness	IIII
Auto-off	OFF
Auto Lamp	OFF
EXIT	

4.4 Auto-Off

Press Plus or Minus to select 1~60min as auto-off time, which means the display will turn off automatically if no operations detected within this period. Default Auto-Off time: 10min

MENU	
Display Settings	Basic Settings
System Unit	km/h
Brightness	IIII
→ Auto-off	9-min
Auto Lamp	OFF
EXIT	

MENU	
Display Settings	
System Unit	km/h
Brightness	I
→ Auto-off	5-min
Auto Lamp	OFF
EXIT	

MENU	
Display Settings	
System Unit	mph
Brightness	IIII
→ Auto-off	OFF
Auto Lamp	OFF
EXIT	

4.5 Auto-Lamp On/Off

Press and hold On/Off Key to turn on or off the front light automatically.

MENU	
Display Settings	
System Unit	km/h
Brightness	I
Auto-off	5-min
→ Auto Lamp	OFF
EXIT	

MENU	
Display Settings	
System Unit	mph
Brightness	IIII
Auto-off	OFF
→ Auto Lamp	ON
EXIT	

Digital scenario or analog scenario switch. * The current version only supports digital scenario

4.6 Battery Indication

Press Plus or Minus to select among Voltage/Percentage/Off. Battery Indicator on the display will toggle among voltage value, battery percentage left and none.

* Battery percentage display requires system-BMS communications.

MENU	
Display Settings	Basic Settings
→ Battery Ind	Voltage
EXIT	

MENU	
Display Settings	Basic Settings
→ Battery Ind	Percent
EXIT	

MENU	
Display Settings	Basic Settings
→ Battery Ind	OFF
EXIT	

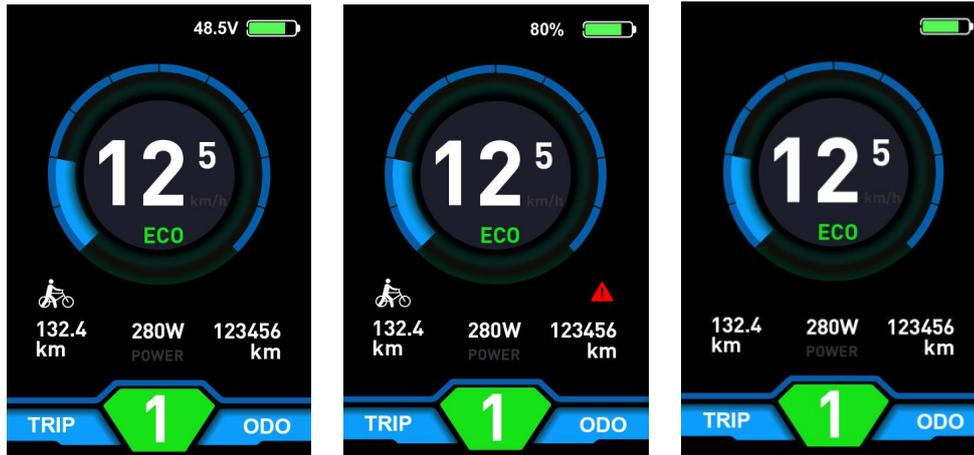

4.7 Wheel Size

Press Plus or Minus to set the correct wheel size. Default wheel size: 26inch. Incorrect or inaccurate wheel size may lead to incorrect speed display. Unit: inch, increment 0.1inch.

MENU	
Display Settings	Basic Settings
→ Wheel	12inch
Battery	36V
Low Battery	>
Password settings	>

MENU	
Display Settings	Basic Settings
→ Wheel	31inch
Battery	36V
Low Battery	>
Password settings	>

MENU	
Display Settings	Basic Settings
→ Advanced Settings	>
Factory Settings	>
Information	>
EXIT	

4.8 Voltage Level

Press Plus or Minus to select. Working voltage range: 24~72V.

MENU	
Display Settings	Basic Settings
Wheel	12inch
→ Battery	24V
Low Battery	>
Password settings	>

MENU	
Display Settings	Basic Settings
Wheel	31inch
→ Battery	36V
Low Battery	>
Password settings	>

MENU	
Display Settings	Basic Settings
Wheel	31inch
→ Battery	48V
Low Battery	>
Password settings	>

4.9 Low Battery Level

In light of low battery protection volt level, press Plus or Minus to set low battery protection level for the vehicle.

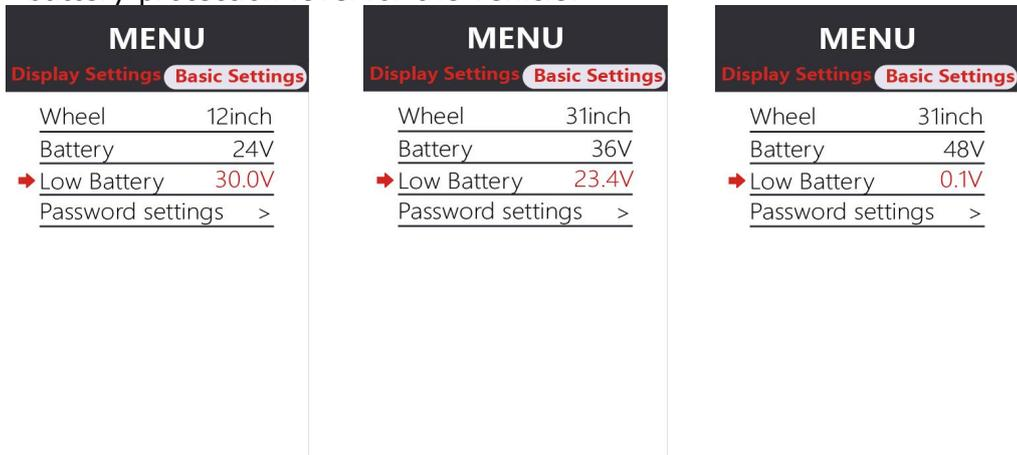

4.10 Boot Password

Press the Info Key to enter Password Settings. First to set is 4-digit boot password (as shown in the pictures below). Then you can set in turn passwords for setting menu, basic settings, advanced settings and change password.

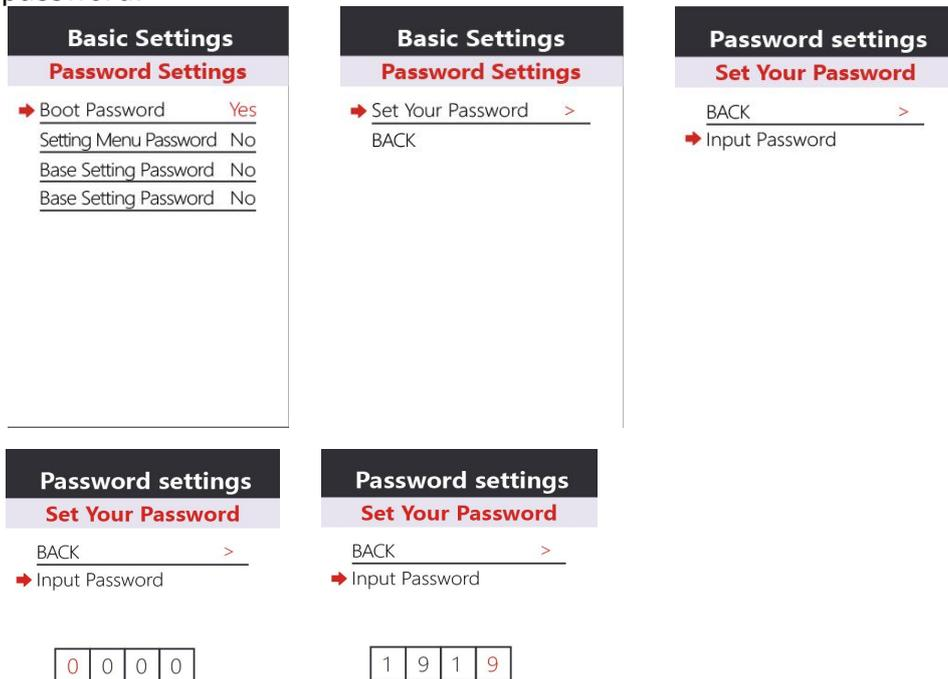

4.11 Advanced Settings

Press On/Off Key to enter Advanced Settings. For password protected product, enter the correct password and press On/Off Key to enter Advanced Setting. Press Plus or Minus to set values, then press On/Off Key to save and switch to the next item.

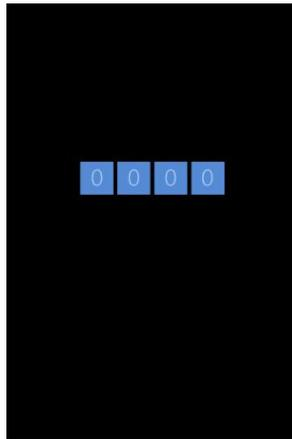

4.12 Speed Limit

Press Plus or Minus to set values for speed limit. Min. Value: 10km/h, Max. Value: 100km/h, increment: 1km/h. Default speed limit: 100km/h.

Basic Settings	
Advanced Settings	
→ Speed limit	10km/h
Current limit	18A
Auto Cruise	No
Assist levels	5

Basic Settings	
Advanced Settings	
→ Speed limit	25km/h
Current limit	18A
Auto Cruise	No
Assist levels	5

Basic Settings	
Advanced Settings	
→ Speed limit	45km/h
Current limit	18A
Auto Cruise	No
Assist levels	5

4.13 Current Limit

Press Plus or Minus to set values for current limit. Min. Value: 6A, Max. Value: 50A. Default speed limit: 15A.

Basic Settings	
Advanced Settings	
Speed limit	10km/h
→ Current limit	6A
Auto Cruise	No
Assist levels	5

Basic Settings	
Advanced Settings	
Speed limit	25km/h
→ Current limit	15A
Auto Cruise	No
Assist levels	5

Basic Settings	
Advanced Settings	
Speed limit	45km/h
→ Current limit	18A
Auto Cruise	No
Assist levels	5

4.14 Auto-Cruise

Press Plus or Minus to turn on or off the auto-cruise function.

Basic Settings	
Advanced Settings	
Speed limit	10km/h
Current limit	6A
➔ Auto Cruise	No
Assist levels	5

Basic Settings	
Advanced Settings	
Speed limit	25km/h
Current limit	15A
➔ Auto Cruise	Yes
Assist levels	5

4.15 Assist Levels

Press Plus or Minus to select assist level mode: 3 levels / 5 levels.

Basic Settings	
Advanced Settings	
Speed limit	25km/h
Current limit	15A
Auto Cruise	Yes
➔ Assist levels	3

Basic Settings	
Advanced Settings	
Speed limit	10km/h
Current limit	6A
Auto Cruise	No
➔ Assist levels	5

4.16 Torque Level Range

Press Plus or Minus to select signal voltage level for torque sensor:
500mV / 3500mV.

Basic Settings	
Advanced Settings	
➔ Torque level range	500mV
Poles in motor	46
Start motor	Zero
Driver mode	2

Basic Settings	
Advanced Settings	
➔ Torque level range	1000mV
Poles in motor	46
Start motor	Zero
Driver mode	2

Basic Settings	
Advanced Settings	
➔ Torque level range	3500mV
Poles in motor	46
Start motor	Zero
Driver mode	2

4.17 Poles in Motor

Press Plus or Minus to set number of magnetic poles for speed gauge.
Min. Value: 1, Max. Value: 255. Default poles number: 1.

Basic Settings	
Torque level range 500mV	
→ Poles in motor	46
Start motor	Zero
Driver mode	2

Basic Settings	
Torque level range 1000mV	
→ Poles in motor	50
Start motor	Zero
Driver mode	2

Basic Settings	
Torque level range 3500mV	
→ Poles in motor	69
Start motor	Zero
Driver mode	2

4.18 Start Mode

Press Plus or Minus to select start mode : Throttle on demand and Throttle after pedal. "Zero" means Throttle on demand, "Non-Zero" means Throttle after pedal.

Basic Settings	
Torque level range 500mV	
Poles in motor	46
→ Start motor	Zero
Driver mode	2

Basic Settings	
Torque level range 1000mV	
Poles in motor	50
→ Start motor	Non Zero
Driver mode	2

4.19 Drive Mode

Press Plus or Minus to select drive mode: 0 / 1 / 2. 0 means pedal assist only, 1 means throttle only, 2 means both modes available.

Basic Settings	
Torque level range 500mV	
Poles in motor	46
Start motor	Zero
→ Driver mode	0

Basic Settings	
Torque level range 500mV	
Poles in motor	46
Start motor	Zero
→ Driver mode	1

Basic Settings	
Torque level range 500mV	
Poles in motor	46
Start motor	Zero
→ Driver mode	2

4.20 PAS Sensor Type

Press Plus or Minus to select PAS Sensor Type: 5 / 8 / 12. This value is the number of magnetic steels on the PAS disc.

Basic Settings	Basic Settings	Basic Settings
Advanced Settings	Advanced Settings	Advanced Settings
→ PAS Disc 5	→ PAS Disc 8	→ PAS Disc 12
Start Sensitivity 1	Start Sensitivity 1	Start Sensitivity 1
Start Strength 0	Start Strength 0	Start Strength 0
EXIT	EXIT	EXIT

4.21 Start Sensitivity

Press Plus or Minus to select start sensitivity range: 1~24. This value is the start latency after pedal.

Basic Settings	Basic Settings	Basic Settings
Advanced Settings	Advanced Settings	Advanced Settings
PAS Disc 5	PAS Disc 5	PAS Disc 5
→ Start Sensitivity 1	→ Start Sensitivity 2	→ Start Sensitivity 3
Start Strength 0	Start Strength 0	Start Strength 0
EXIT	EXIT	EXIT

4.22 Start Strength

Press Plus or Minus to select start sensitivity range: 0~5. This value is the start power output after pedal.

Basic Settings	Basic Settings
Advanced Settings	Advanced Settings
PAS Disc 5	PAS Disc 5
Start Sensitivity 1	→ Start Sensitivity 2
→ Start Strength 1	Start Strength 5
EXIT	EXIT

4.23 Factory Reset

Press the On/Off key to enter the Factory Reset Interface. Select YES to reset to factory setting, select Exit to return to the previous menu.

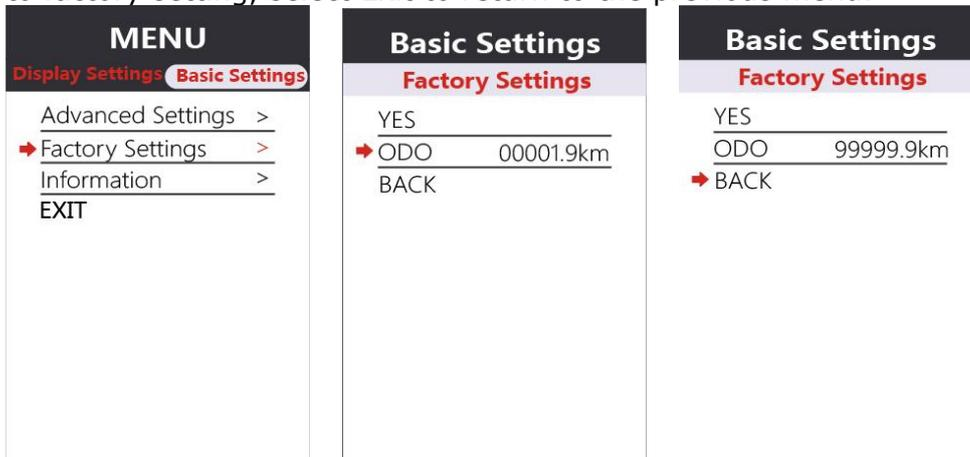

4.24 Information

Press the On/Off key to enter the information interface and check info like speed record, distance record and serial numbers, etc.

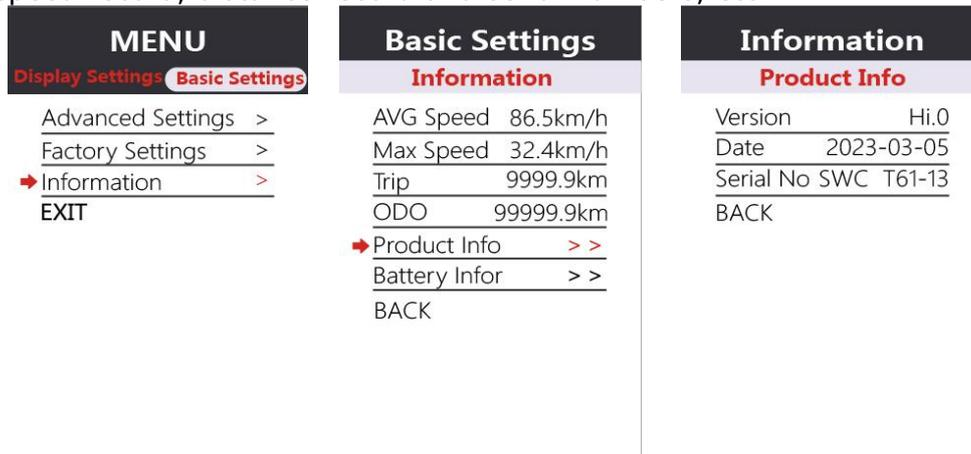

5. Error Code

Error Code (decimal)	Status	Note
E00	Normal	
E01	Reserved	
E02	Brake Error	
E03	PAS Sensor Error (Riding Mark)	Not Realized
E04	Walk Assist Mode	
E05	Real-Time Cruise	
E06	Low Voltage Protection	
E07	Motor Error	
E08	Throttle Error	

E09	Controller Error	
E10	Communications Error	
E12	BMS Communications Error	
E13	Front Light Error	

6. Connection

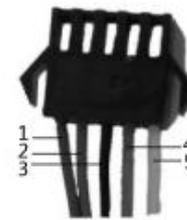
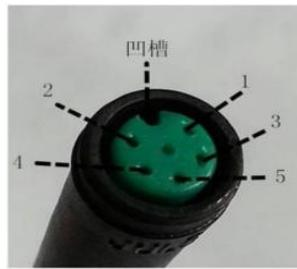
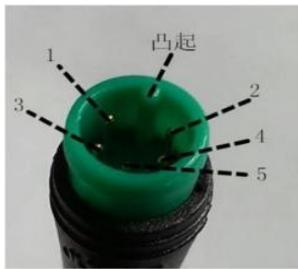

Display to Controller Controller to Display Controller Connector

Pin No.	Wire Color	Functions
1	Red (VCC)	Display Power Wire
2	Blue (K)	Electric Lock Wire
3	Black (GND)	Display Ground Wire
4	Green (RX)	Display Data Receiving Wire
5	Yellow (TX)	Display Data Sending Wire

Extended Functions- Front Light:

Brown (DD): The power wire (+) of the light

White (GND): The ground wire (\cong) of the light.

Note: For waterproof connectors, wire sequences are concealed.

IV. Warranty

In compliance with local laws, Sciwil provides limited warranty period covering **24 months** after the date of manufacturing (as indicated by the serial number), applies to quality issues during normal operations.

The limited warranty shall not be transferred to a third party other than as specified in the agreement with Sciwil.

Warranty Exclusions:

- Sciwil products that have been opened, modified or repaired without

authorization.

- Damage on the connectors.
- Damage to the surface after leaving factory, including shell, screen, buttons, or other appearance parts.
- Damage to wiring and cables after leaving factory, including breaks and exterior scratch.
- Damage or loss due to force majeure (e.g. fire or earthquake) or natural disaster (e.g. lightning).
- Out of the warranty period.

V. Version

This display user manual is in compliance with the general software version (A/0) of Changzhou Sciwil E-Mobility Technology Co., Ltd. There are chances that display products on some e-bikes may have a different software version, which is subject to the actual version in use.